

校園圍牆工程 現況與設計

408450049 顧洵銘 408450166 王予凡
408450520 吳念恩 408450568 林恩如
408450594 林郁凡 408450647 林仲堃
408450635 邱羿綺



目 錄

1

圍牆現況分析

圍牆改造平面圖

2

3

設計構想

圍牆改造剖面圖

4

5

分工表

CONTENTS



01 圍牆現況分析



圍牆現況分析

- 本組為第一組，負責的圍牆範圍是在天主教輔仁大學西側與514巷相接的圍牆，長度約為366米。
- 校內經過理工學院、網球場、外語學院、立言格物宿舍等，一直延續到校外的7-11輔明門市。



圍牆現況分析

圍牆現況老舊，內側像是水泥粉面，青苔遍佈，有不少牆面已剝落，外側有包覆洗石子，看起來視覺效果稍好。



圍牆內側實拍



圍牆外側街景

圍牆現況分析

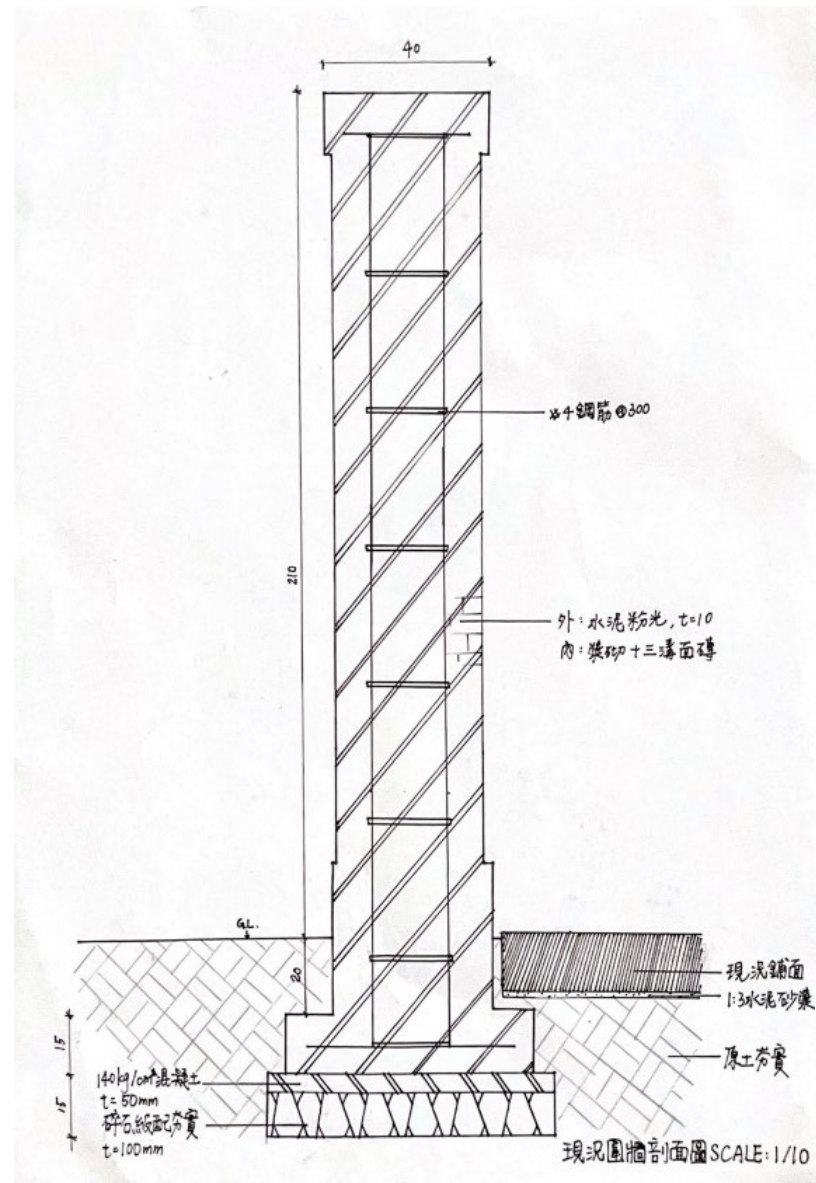

圍牆現況工程圖



02 圍牆改造平面圖



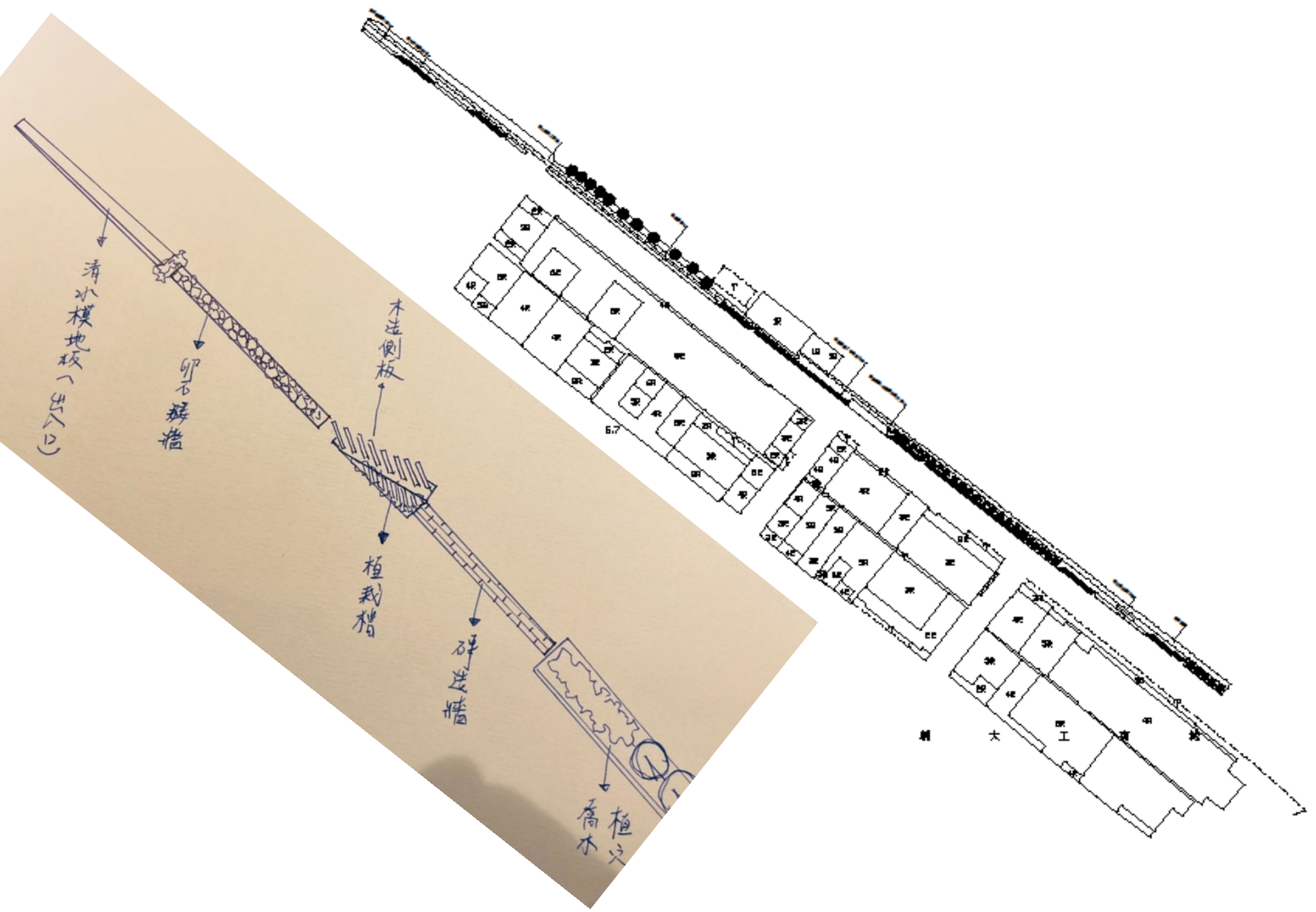



03 設計構想



“

為了打開校園與工商城融合成位大學城。

使用開放性與軟性的圍牆，低矮圍牆作為組成，

期待能將校園的學識以及工商城的實務精神融會貫通形成學生的涵養。



04 圍牆改造剖面圖



圍牆改造平面圖

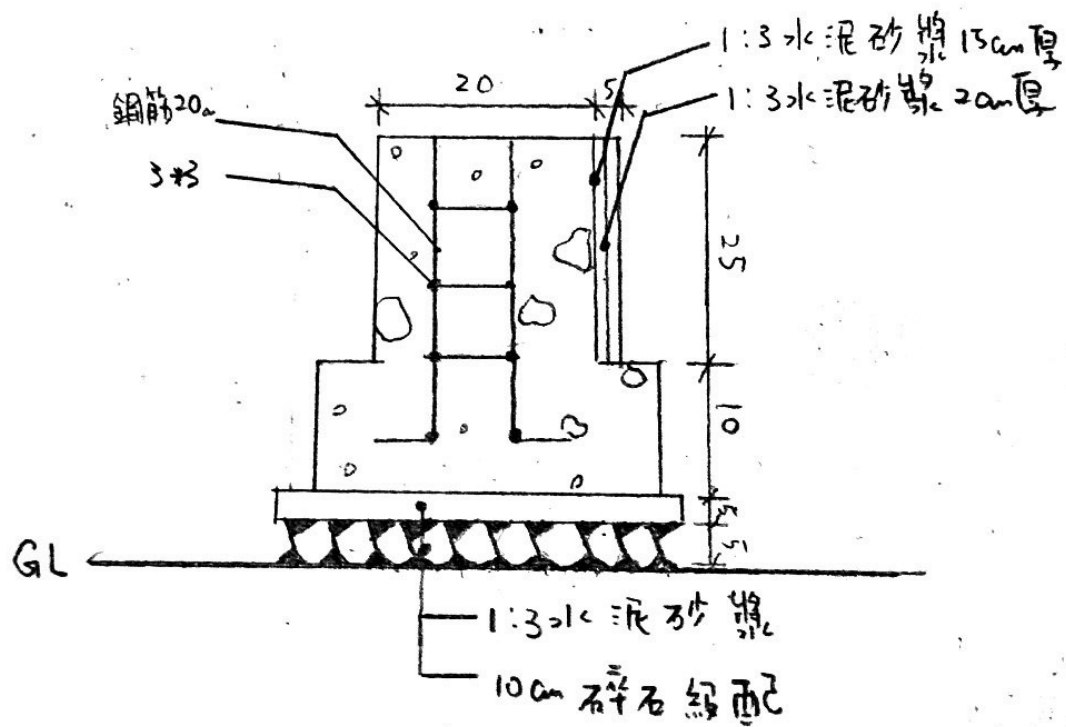
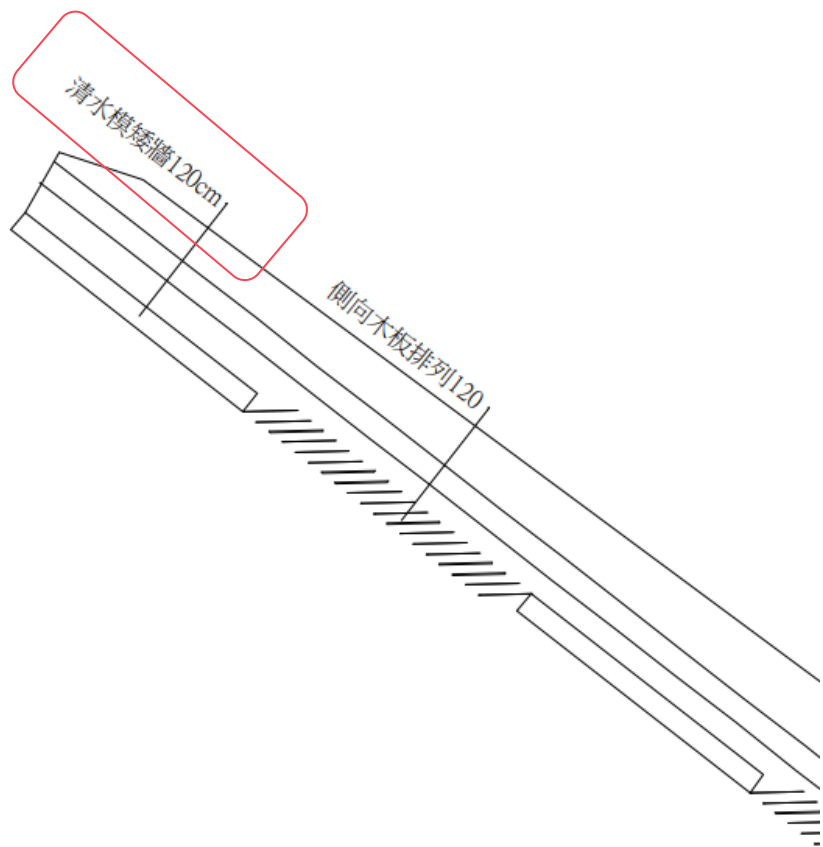

清水模矮牆施工圖

SCALE: 1/20 (cm)

清水模矮牆施工圖

圍牆改造平面圖

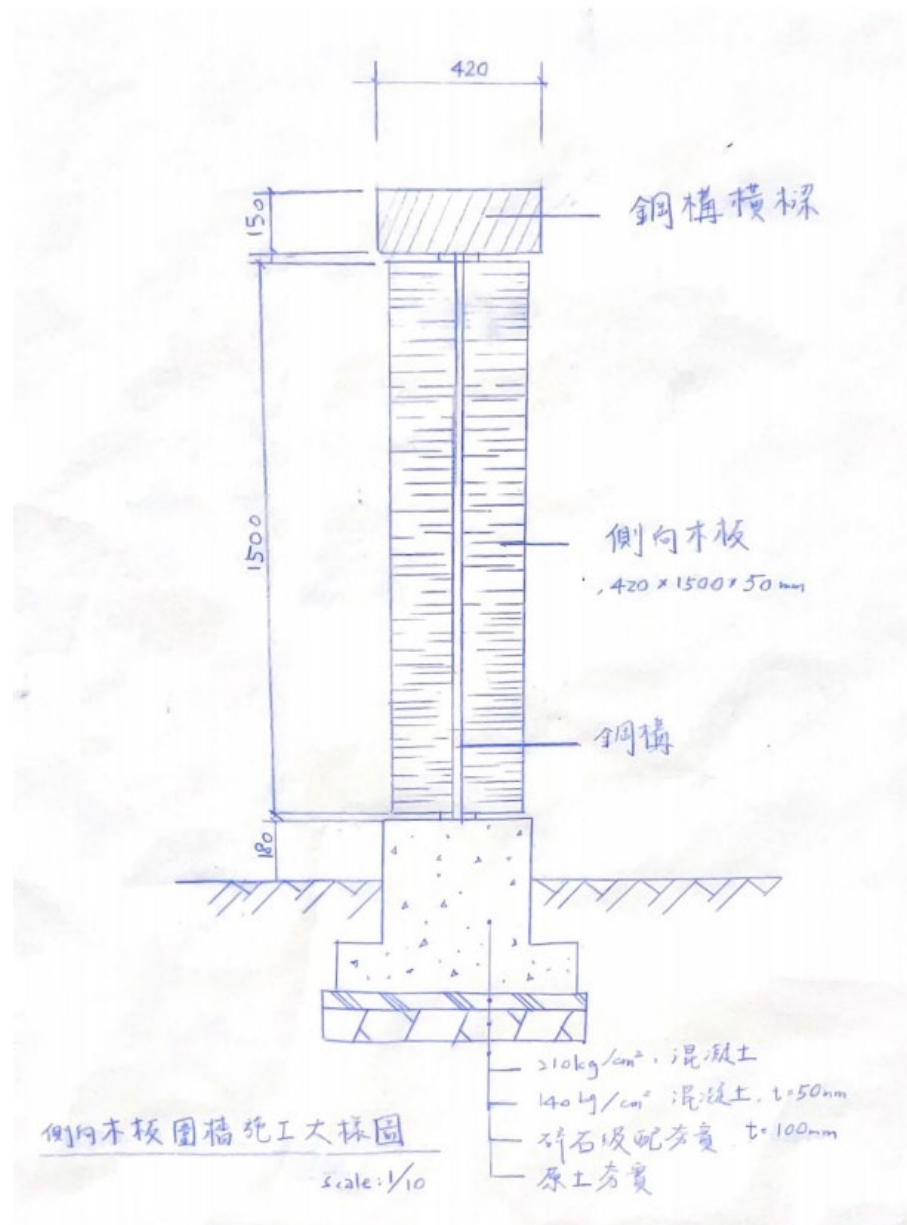
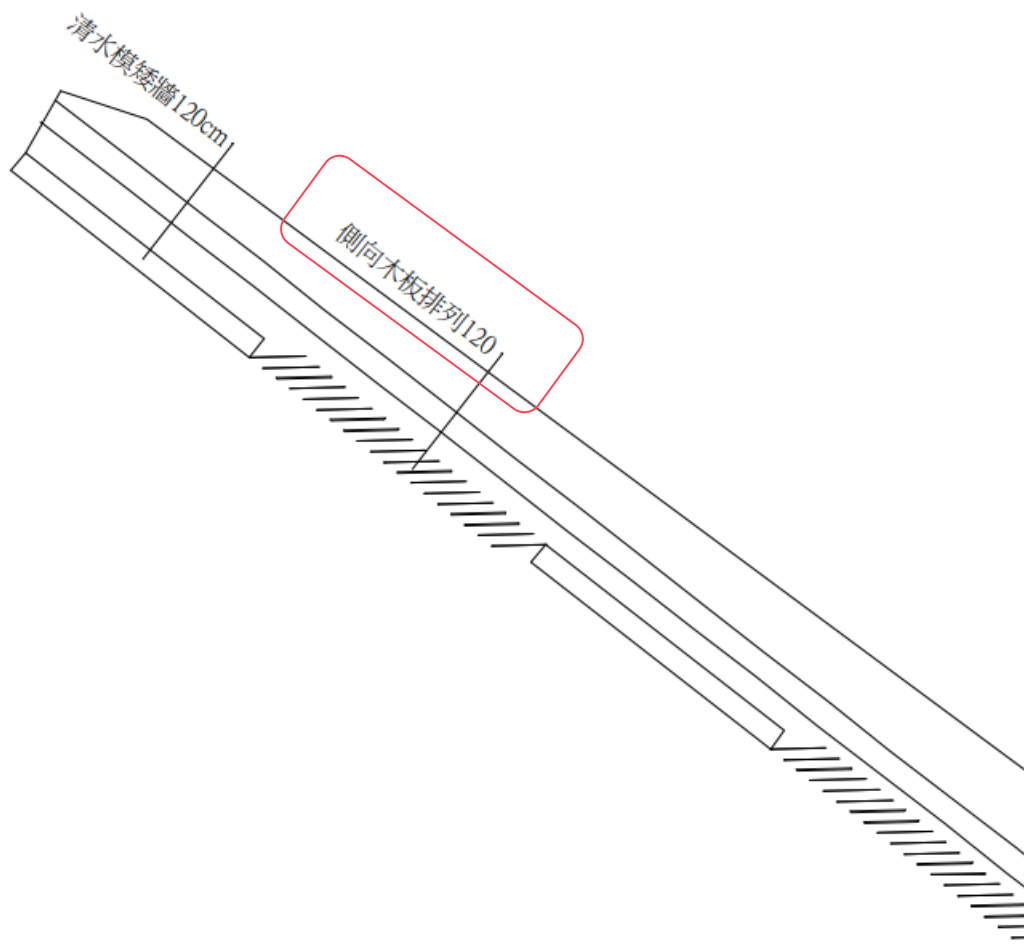

側向木板施工圖

工商城連接

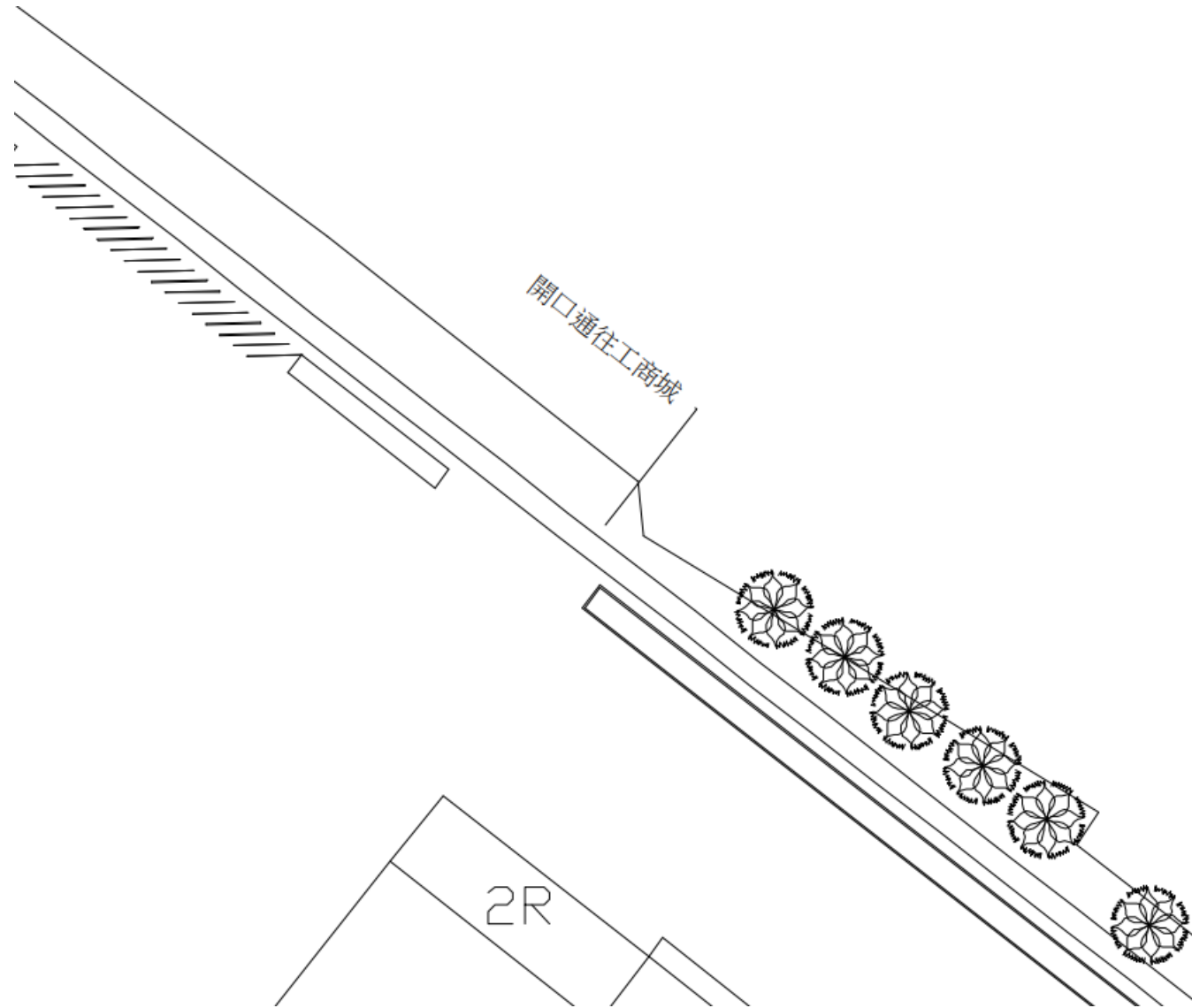

圍牆改造平面圖

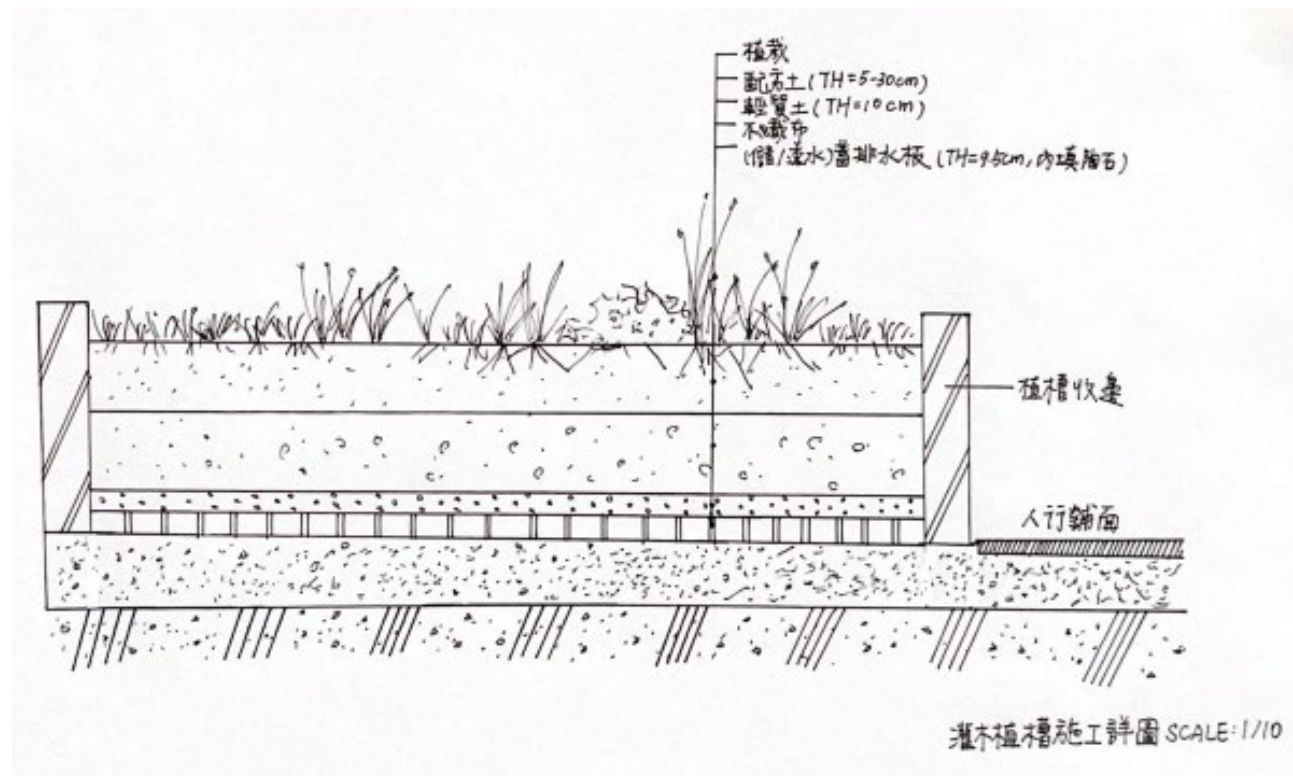
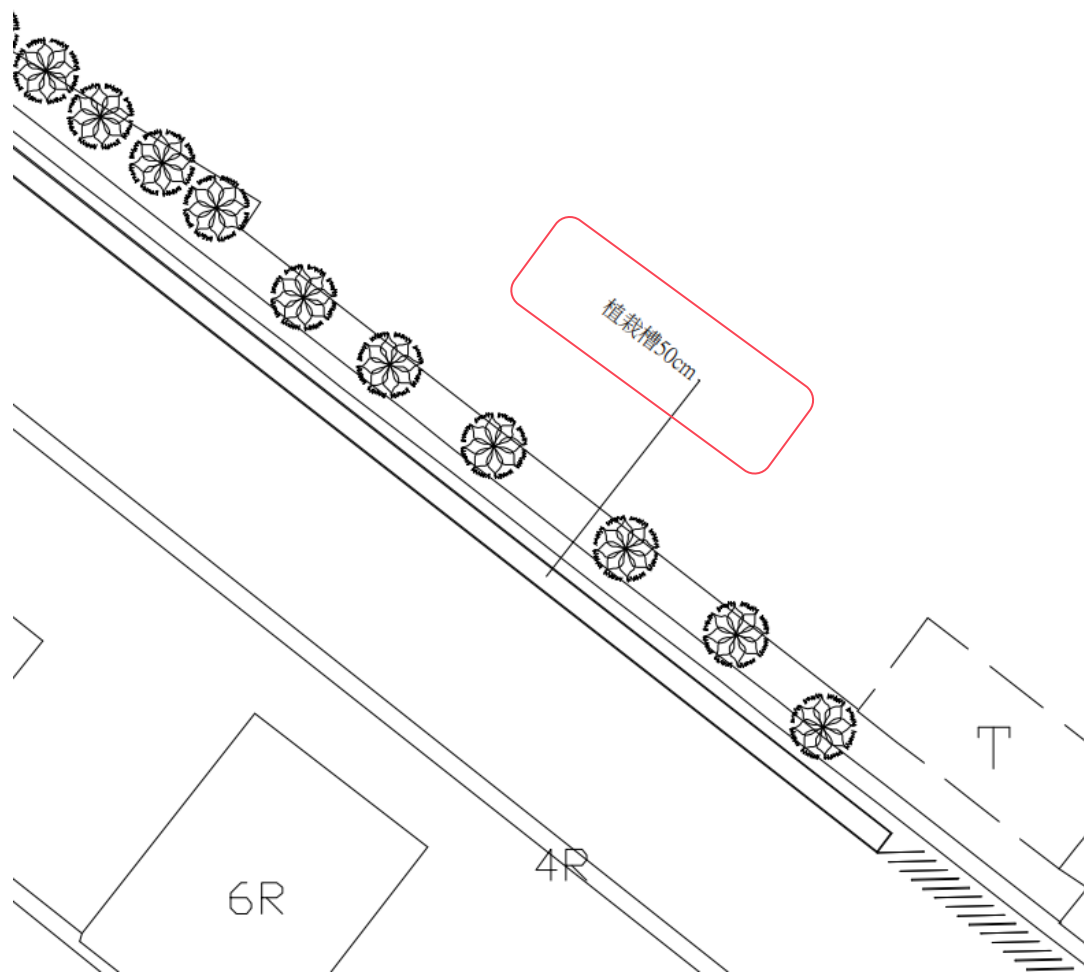

植栽槽施工圖

圍牆改造平面圖

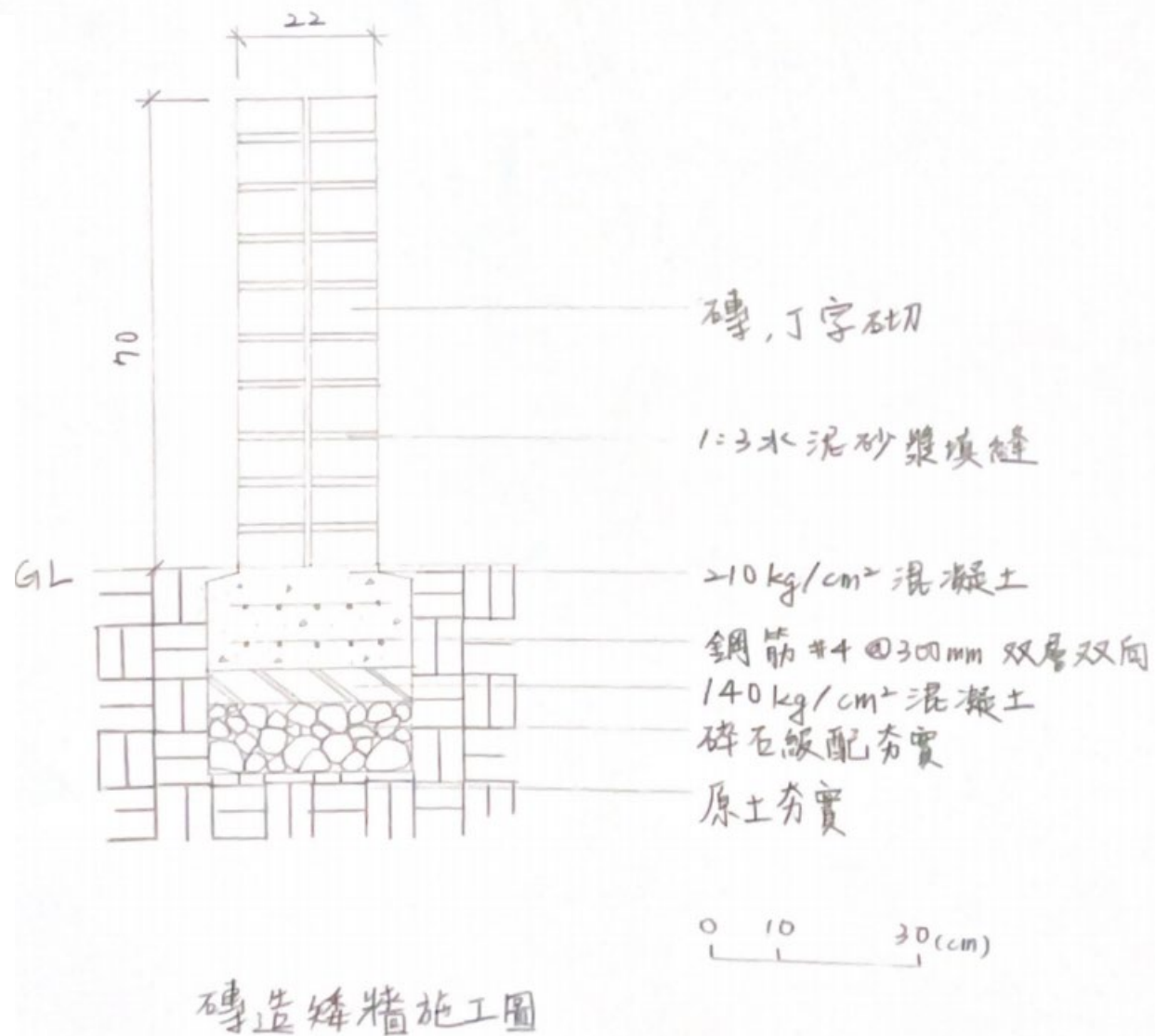
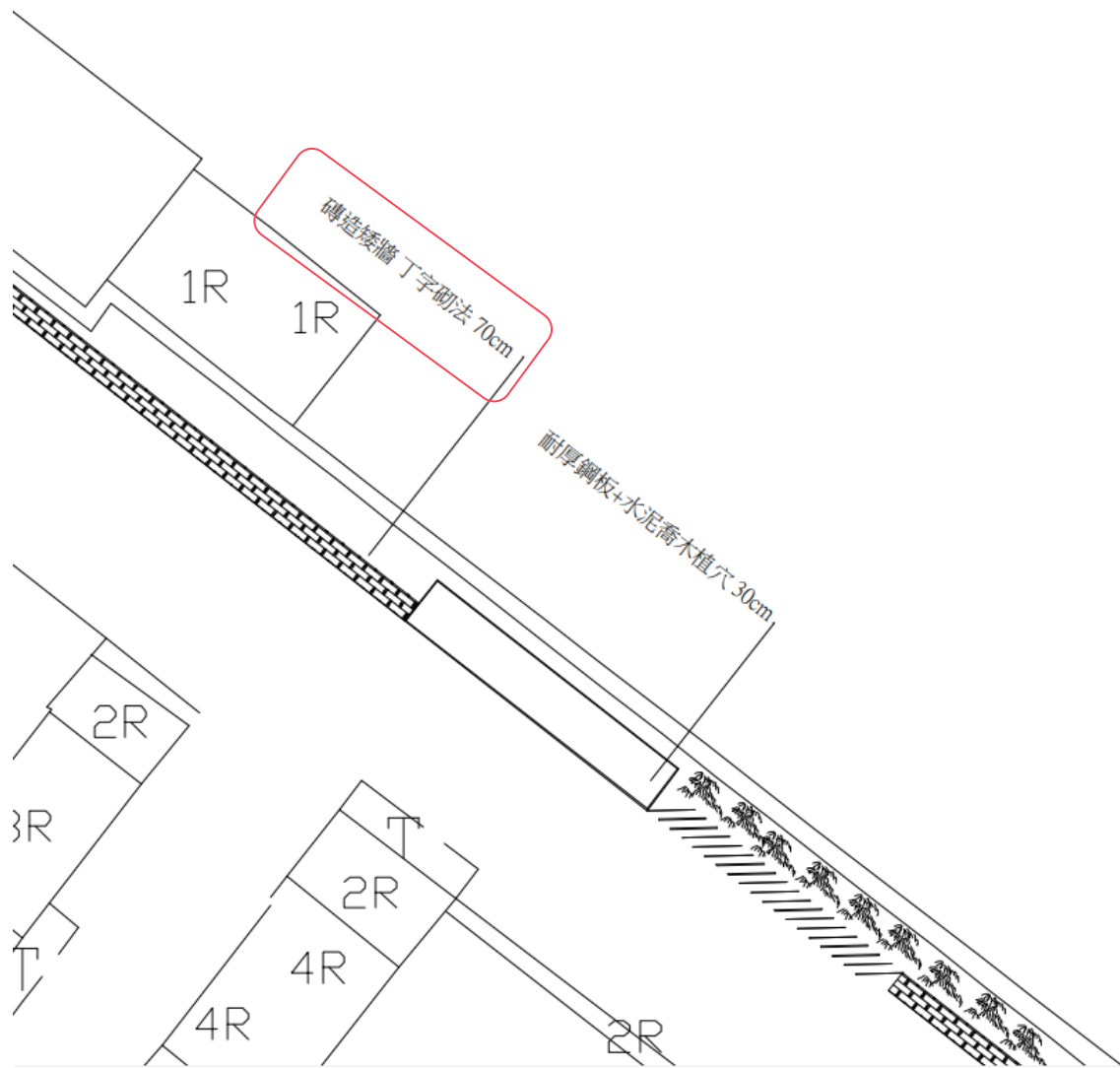

磚造矮牆 丁字砌法施工圖

圍牆改造平面圖

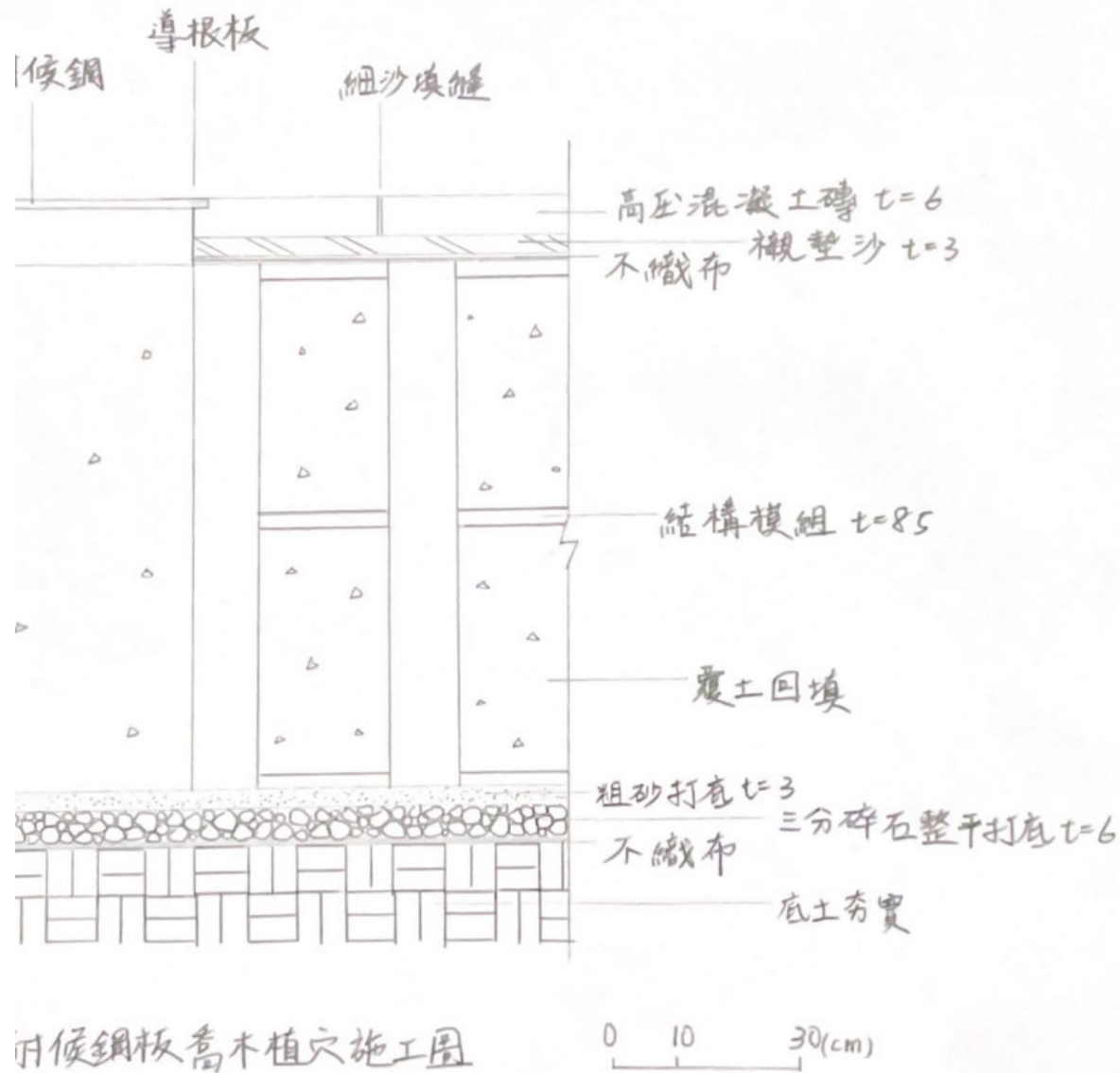
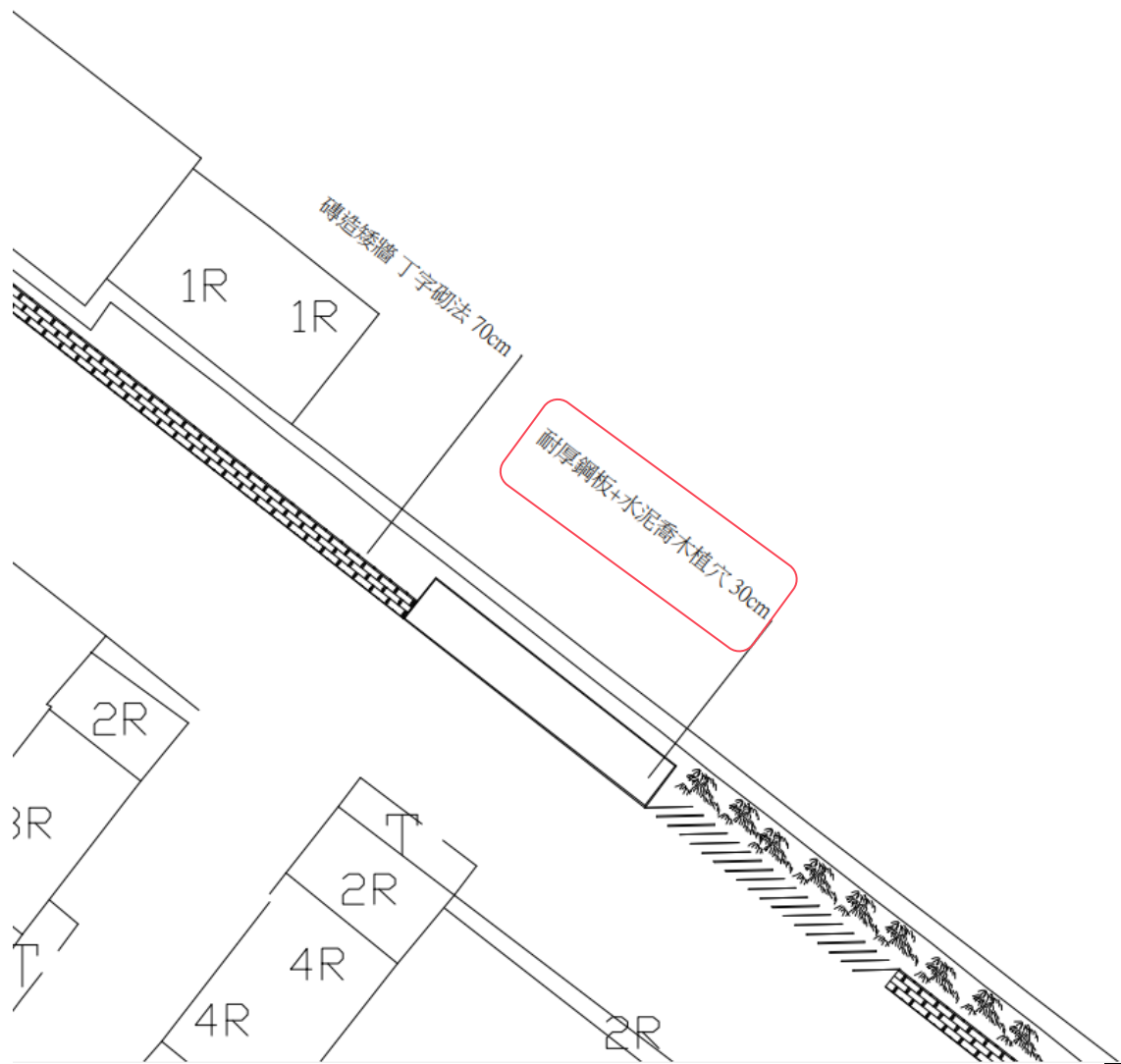

耐候鋼板 + 水泥喬木植穴施工圖



05 分工表



吳念恩

圍牆平面圖
設計構想



顧洵銘

現況分析
PPT製作



邱羿綺

清水模矮牆施工圖



林恩如

側向木板排列施工圖



林郁凡

現況施工圖
植栽槽施工圖



王予凡

磚造矮牆施工圖
耐候鋼板水泥植穴施工圖



林仲堃

影片剪輯
成果彙整
PPT製作

**THANKS
YOU**

**校園圍牆工程
現況與設計。**